

SOT-23 Plastic-Encapsulate Transistors

FEATURES

- As complementary type, the NPN transistor TKMMBT3904 is Recommended
- Epitaxial planar die construction

MARKING: 2A

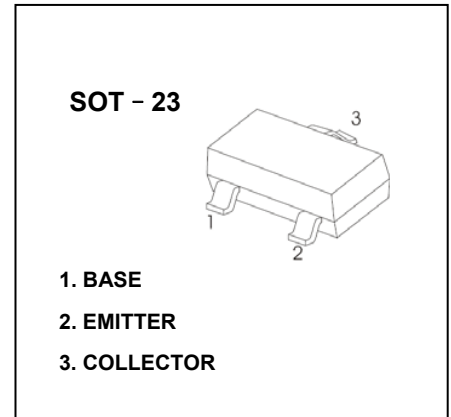

MAXIMUM RATINGS ( $T_A=25^{\circ}\text{C}$  unless otherwise noted)

Symbol	Parameter	Value	Unit
$V_{CB0}$	Collector-Base Voltage	-40	V
$V_{CEO}$	Collector-Emitter Voltage	-40	V
$V_{EBO}$	Emitter-Base Voltage	-5	V
$I_C$	Collector Current -Continuous	-0.2	A
$P_C$	Collector Dissipation	0.2	W
$R_{\theta JA}$	Thermal resistance junction to ambient	625	$^{\circ}\text{C}/\text{W}$
$T_J$	Junction Temperature	150	$^{\circ}\text{C}$
$T_{stg}$	Storage Temperature	-55~+150	$^{\circ}\text{C}$

ELECTRICAL CHARACTERISTICS ( $T_{amb}=25^{\circ}\text{C}$  unless otherwise specified)

Parameter	Symbol	Test conditions	MIN	MAX	UNIT
Collector-base breakdown voltage	$V_{(BR)CBO}$	$I_C=-10\mu\text{A}, I_E=0$	-40		V
Collector-emitter breakdown voltage	$V_{(BR)CEO}$	$I_C=-1\text{mA}, I_B=0$	-40		V
Emitter-base breakdown voltage	$V_{(BR)EBO}$	$I_E=-10\mu\text{A}, I_C=0$	-5		V
Collector cut-off current	$I_{CBO}$	$V_{CB}=-40\text{V}, I_E=0$		-100	nA
Collector cut-off current	$I_{CEX}$	$V_{CE}=-30\text{V}, V_{BE(off)}=-3\text{V}$		-50	nA
Emitter cut-off current	$I_{EBO}$	$V_{EB}=-5\text{V}, I_C=0$		-100	nA
DC current gain	$h_{FE1}$	$V_{CE}=-1\text{V}, I_C=-10\text{mA}$	100	300	
	$h_{FE2}$	$V_{CE}=-1\text{V}, I_C=-50\text{mA}$	60		
	$h_{FE3}$	$V_{CE}=-2\text{V}, I_C=-100\text{mA}$	30		
Collector-emitter saturation voltage	$V_{CE(sat)1}$	$I_C=-50\text{mA}, I_B=-5\text{mA}$		-0.3	V
Base-emitter saturation voltage	$V_{BE(sat)}$	$I_C=-50\text{mA}, I_B=-5\text{mA}$		-0.95	V
Transition frequency	$f_T$	$V_{CE}=-20\text{V}, I_C=-10\text{mA}, f=100\text{MHz}$	300		MHz
Delay Time	$t_d$	$V_{CC}=-3\text{V}, V_{BE}=-0.5\text{V}$ $I_C=-10\text{mA}, I_{B1}=I_{B2}=-1\text{mA}$		35	nS
Rise Time	$t_r$			35	nS
Storage Time	$t_s$	$V_{CC}=-3\text{V}, I_C=-10\text{mA}$ $I_{B1}=I_{B2}=-1\text{mA}$		225	nS
Fall Time	$t_f$			75	nS

CLASSIFICATION OF  $h_{FE(1)}$

HFE	100-300
-----	---------

## Typical Characteristics

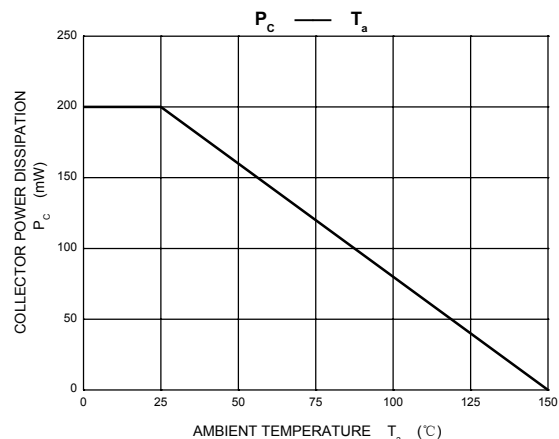
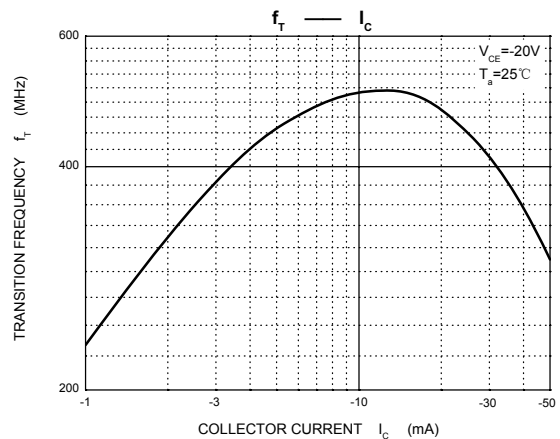
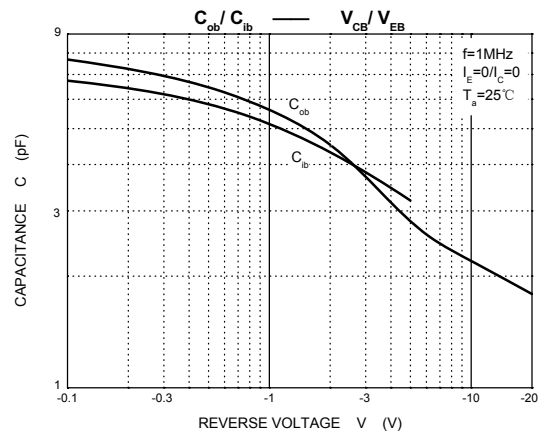
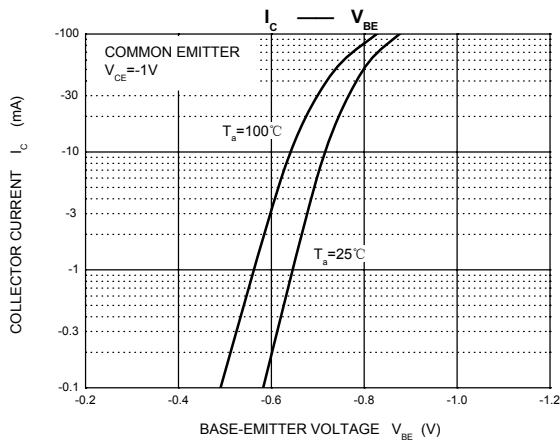
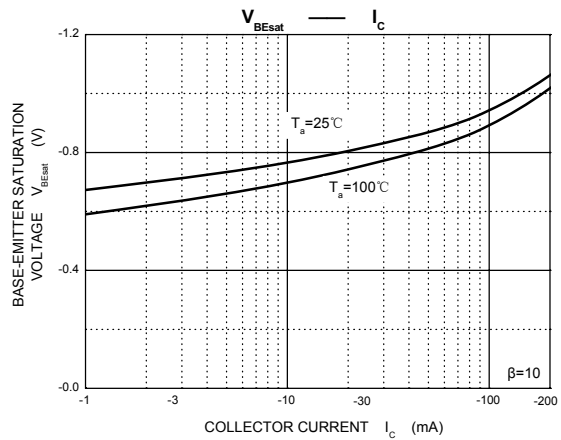
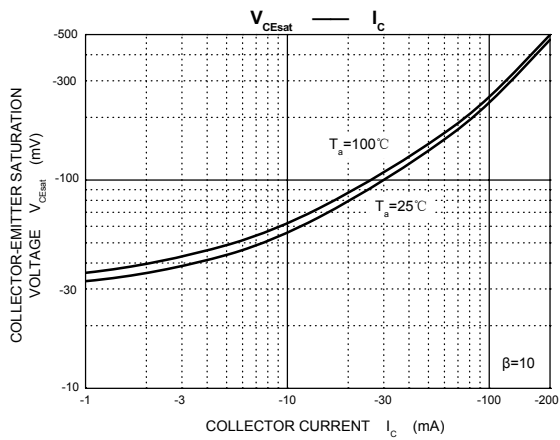
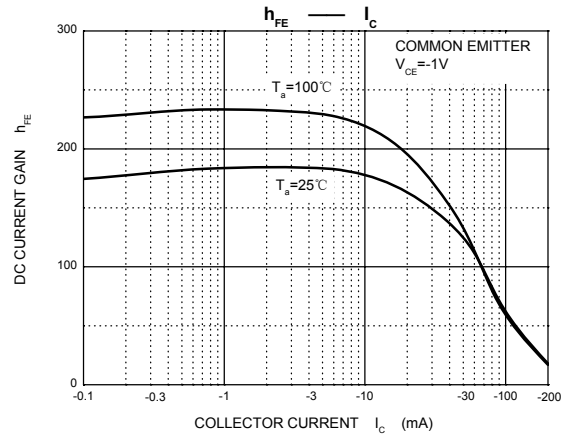
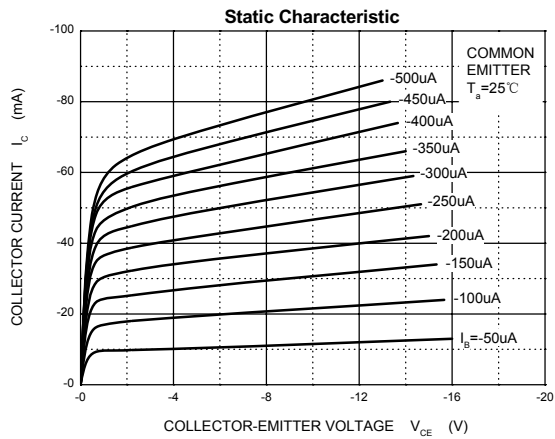

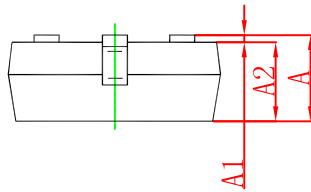
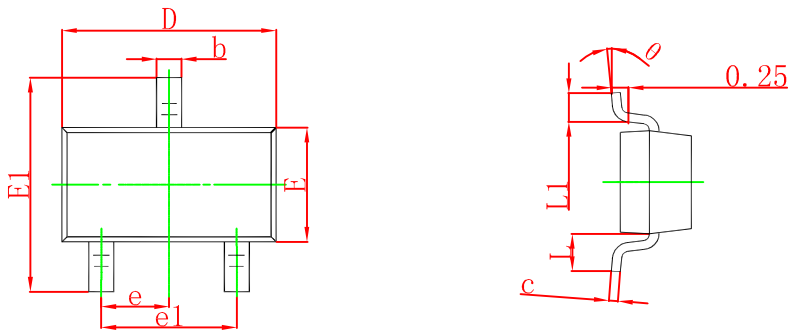

Symbol	Dimensions In Millimeters		Dimensions In Inches	
	Min	Max	Min	Max
A	0.900	1.150	0.035	0.045
A1	0.000	0.100	0.000	0.004
A2	0.900	1.050	0.035	0.041
b	0.300	0.500	0.012	0.020
c	0.080	0.150	0.003	0.006
D	2.800	3.000	0.110	0.118
E	1.200	1.400	0.047	0.055
E1	2.250	2.550	0.089	0.100
e	0.950 TYP		0.037 TYP	
e1	1.800	2.000	0.071	0.079
L	0.550 REF		0.022 REF	
L1	0.300	0.500	0.012	0.020
θ	0°	8°	0°	8°

### SOT-23 Suggested Pad Layout

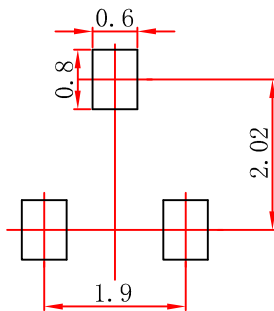

- Note:
1. Controlling dimension: in millimeters.
  2. General tolerance:  $\pm 0.05$  mm.
  3. The pad layout is for reference purposes only.