

G399/G288

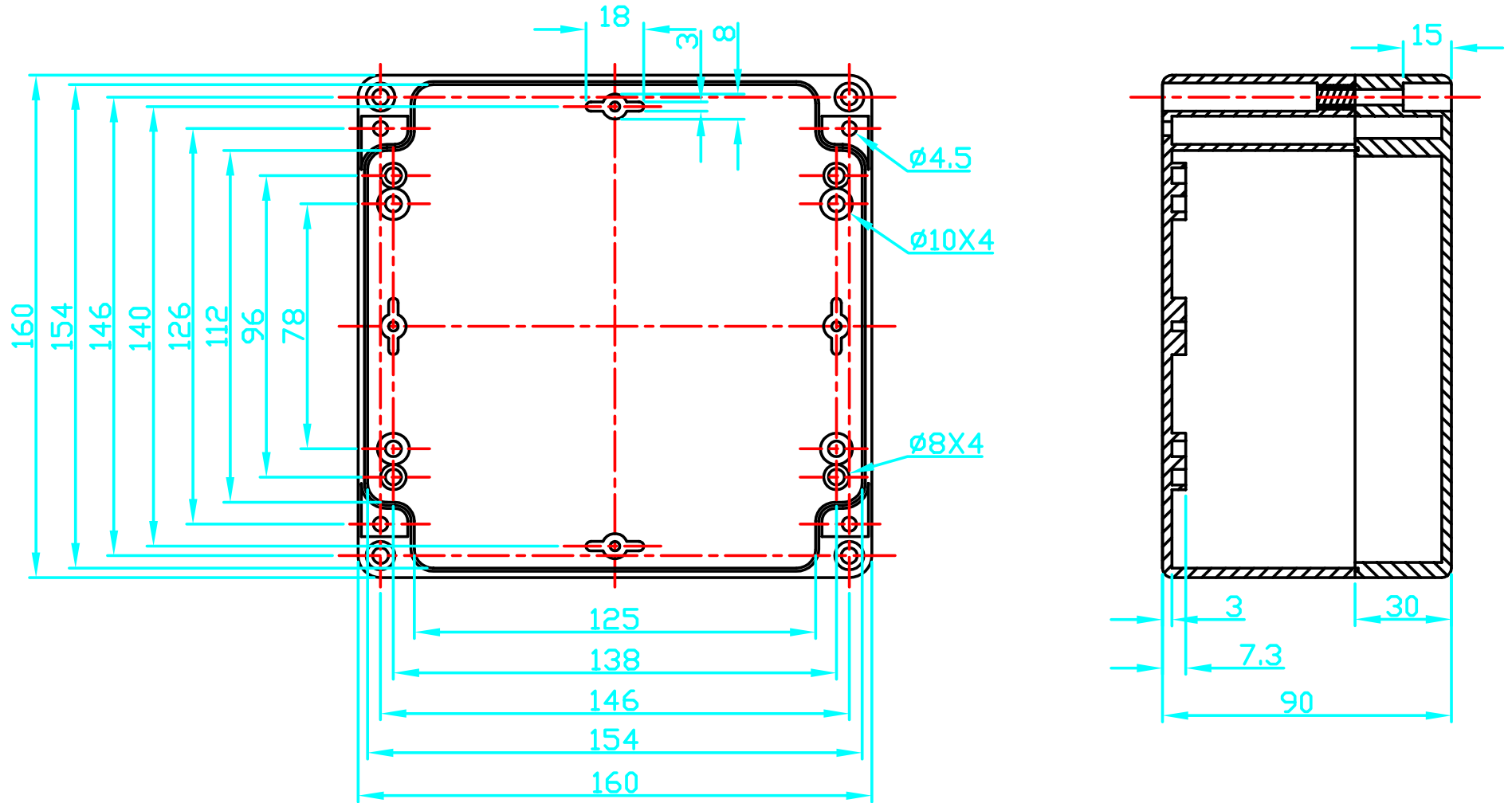

宜又實業有限公司 GAINTA INDUSTRIES LTD.	設計 DES'D BY	繪圖 DRA'D BY	核圖 CHK'D BY	比例 SCALE	日期 DATE	材質 MATE.	圖名 TITLE	圖號 DWG NO.	圖號 REVISID	說明 DESCRIPTION
						ABS,PC	G399,G288			