

SURFACE MOUNT SUPER FAST RECTIFIER

FEATURES

- Plastic package has Underwrites Laboratory Flammability Classification 94V-0
- Glass passivated chip junction
- Built-in strain relief
- Super Fast switching speed for high efficiency
- High temperature soldering guaranteed: 250°C/10 seconds

MECHANICAL DATA

- Case: JEDED DO-214AA transfer molded plastic
- Terminals: Solder plated, Solderable per MIL-STD-750, Method 2026
- Polarity: Color band denotes cathode end
- Weight: 0.003 ounce, 0.093 gram

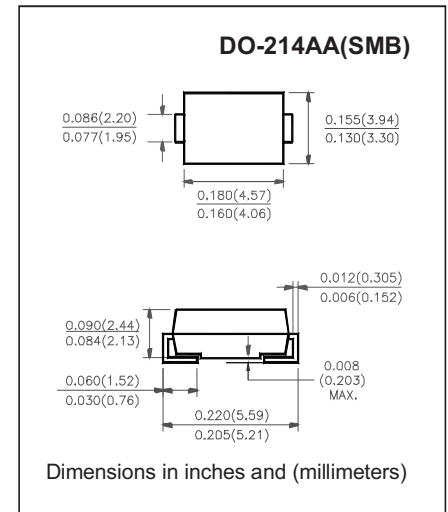

MAXIMUM RATINGS AND ELECTRICAL CHARACTERISTICS

- Ratings at 25 °C ambient temperature unless otherwise specified. Single phase, half wave, 60Hz, resistive or inductive load
For capacitive load derate current by 20%.

	SYMBOLS	ES2A	ES2B	ES2C	ES2D	ES2E	ES2G	ES2J	UNIT
Maximum Repetitive Peak Reverse Voltage	V_{RRM}	50	100	150	200	300	400	600	Volts
Maximum RMS Voltage	V_{RMS}	35	70	105	140	210	280	420	Volts
Maximum DC Blocking Voltage	V_{DC}	50	100	150	200	300	400	600	Volts
Maximum Average Forward Rectified Current at $T_L=100^\circ\text{C}$	$I_{(AV)}$	2.0							Amps
Peak Forward Surge Current 8.3ms single half sine wave superimposed on rated load (JEDEC method)	I_{FSM}	50							Amps
Maximum Instantaneous Forward Voltage @ 2.0A	V_F	0.95				1.25		1.70	Volts
Maximum DC Reverse Current at rated DC Blocking voltage per element	$T_A=25^\circ\text{C}$	5.0							μA
	$T_A=125^\circ\text{C}$	200							
Maximum Reverse Recovery Time Test conditions $I_F=0.5\text{A}$, $I_R=1.0\text{A}$, $I_{RR}=0.25\text{A}$	t_{rr}	35							nS
Typical Junction Capacitance (Measured at 1.0MHz and applied reverse voltage of 4.0V)	C_J	25			208				pF
Typical Thermal Resistance (Note 1)	$R_{\theta JA}$	75							$^\circ\text{C}/\text{W}$
	$R_{\theta JL}$	17							
Operating Junction Temperature Range	T_J	(-55 to +150)							$^\circ\text{C}$
Storage Temperature Rang	T_{STG}	(-55 to +150)							$^\circ\text{C}$

Notes:

1. Thermal resistance from Junction to ambient and from junction to lead mounted on P.C.B. with 0.3"×0.3"(8.0mm × 8.0mm) copper pad areas.

SURFACE MOUNT SUPER FAST RECTIFIER

RATING AND CHARACTERISTIC CURVES ES2A - ES2J

FIG.1-TYPICAL FORWARD CURRENT DERATING CURVE

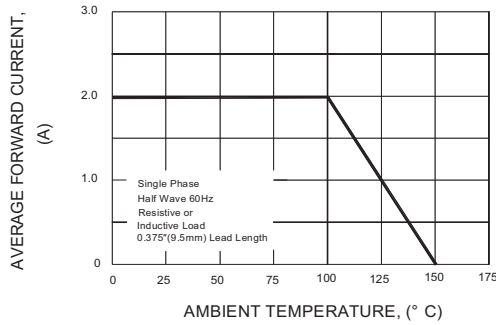

FIG.2-MAXIMUM NON-REPETITIVE PEAK FORWARD SURGE CURRENT

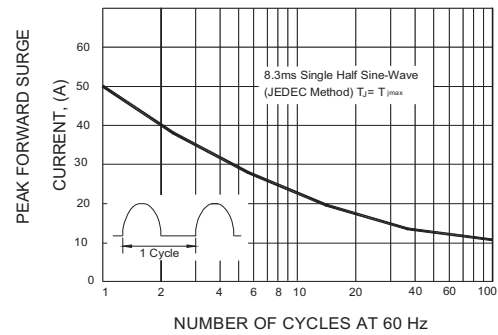

FIG.3-TYPICAL INSTANTANEOUS FORWARD CHARACTERISTICS

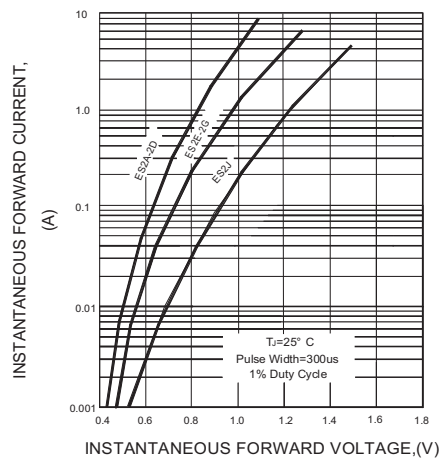

FIG.4-TYPICAL REVERSE CHARACTERISTICS

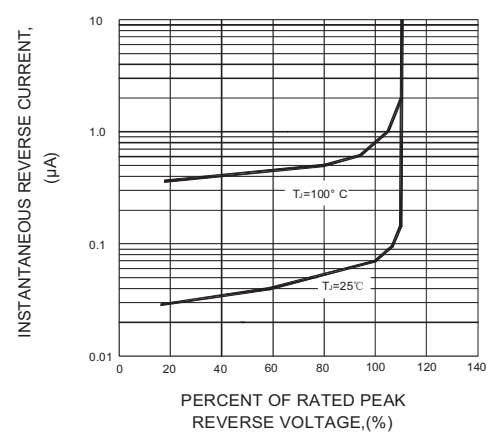

FIG.5-TYPICAL JUNCTION CAPACITANCE

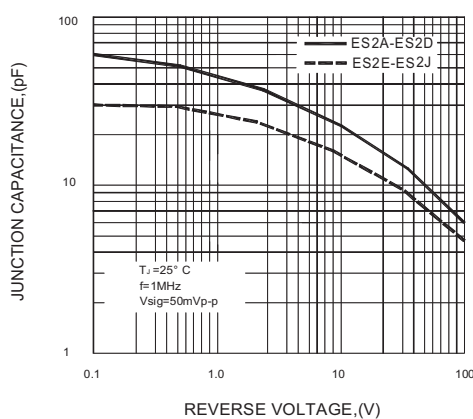
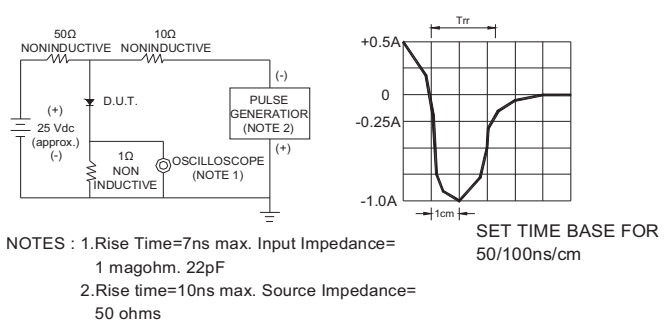

FIG.6-TEST CIRCUIT DIAGRAM AND REVERSE RECOVERY TIME CHARACTERISTIC



Disclaimer

All product, product specifications and data are subject to change without notice to improve reliability, function or design or otherwise.