

## SOT-23 Plastic-Encapsulate Diodes

### FEATURES

- Planar Die Construction
- 300mW Power Dissipation
- Zener Voltages from 2.4V - 39V
- Ultra-Small Surface Mount Package Power Dissipation

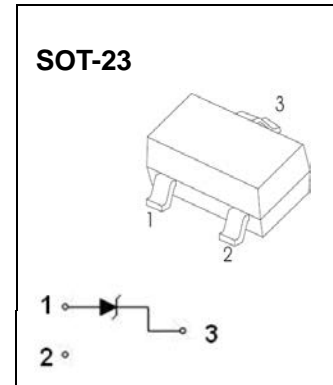

### MAXMUM RATINGS( $T_a=25^{\circ}\text{C}$ unless otherwise specified )

Characteristic	Symbol	Value	Unit
Forward Voltage (Note 2) @ $I_F = 10\text{mA}$	$V_F$	0.9	V
Power Dissipation(Note 1)	$P_d$	300	mW
Thermal Resistance from Junction to Ambient	$R_{\theta JA}$	417	$^{\circ}\text{C}/\text{W}$
Operation Junction and Storage Temperature Range	$T_J, T_{stg}$	-55~+150	

**ELECTRICAL CHARACTERISTICS**
**T =25°C unless otherwise specified**

Type Number	Type Code	Zener Voltage Range (Note 2)				Maximum Zener Impedance (Note 3)			Maximum Reverse Current		Typical Temperature Coefficient @I <sub>ZT</sub> =5 mA	
		V <sub>Z</sub> @I <sub>ZT</sub>			I <sub>ZT</sub>	Z <sub>ZT</sub> @I <sub>ZT</sub>	Z <sub>ZK</sub> @I <sub>ZK</sub>	I <sub>ZK</sub>	I <sub>R</sub>	V <sub>R</sub>	mV/°C	
		Nom(V)	Min(V)	Max(V)	mA	Ω		mA	μA	V	Min	Max
TKBZX84B2V4	2Z11	2.4	2.35	2.45	5	100	600	1.0	50	1.0	-3.5	0
TKBZX84B2V7	2Z12	2.7	2.65	2.75	5	100	600	1.0	20	1.0	-3.5	0
TKBZX84B3V0	2Z13	3	2.94	3.06	5	95	600	1.0	10	1.0	-3.5	0
TKBZX84B3V3	2Z14	3.3	3.23	3.37	5	95	600	1.0	5	1.0	-3.5	0
TKBZX84B3V6	2Z15	3.6	3.53	3.67	5	90	600	1.0	5	1.0	-3.5	0
TKBZX84B3V9	2Z16	3.9	3.82	3.98	5	90	600	1.0	3	1.0	-3.5	0
TKBZX84B4V3	2Z17	4.3	4.21	4.39	5	90	600	1.0	3	1.0	-3.5	0
TKBZX84B4V7	2Z1	4.7	4.61	4.79	5	80	500	1.0	3	2.0	-3.5	0.2
TKBZX84B5V1	2Z2	5.1	5.00	5.20	5	60	480	1.0	2	2.0	-2.7	1.2
TKBZX84B5V6	2Z3	5.6	5.49	5.71	5	40	400	1.0	1	2.0	-2.0	2.5
TKBZX84B6V2	2Z4	6.2	6.08	6.32	5	10	150	1.0	3	4.0	0.4	3.7
TKBZX84B6V8	2Z5	6.8	6.66	6.94	5	15	80	1.0	2	4.0	1.2	4.5
TKBZX84B7V5	2Z6	7.5	7.35	7.65	5	15	80	1.0	1	5.0	2.5	5.3
TKBZX84B8V2	2Z7	8.2	8.04	8.36	5	15	80	1.0	0.7	5.0	3.2	6.2
TKBZX84B9V1	2Z8	9.1	8.92	9.28	5	15	100	1.0	0.5	6.0	3.8	7.0
TKBZX84B10	2Z9	10	9.80	10.20	5	20	150	1.0	0.2	7.0	4.5	8.0
TKBZX84B11	2Y1	11	10.78	11.22	5	20	150	1.0	0.1	8.0	5.4	9.0
TKBZX84B12	2Y2	12	11.76	12.24	5	25	150	1.0	0.1	8.0	6.0	10.0
TKBZX84B13	2Y3	13	12.74	13.26	5	30	170	1.0	0.1	8.0	7.0	11.0
TKBZX84B15	2Y4	15	14.70	15.30	5	30	200	1.0	0.1	10.5	9.2	13.0
TKBZX84B16	2Y5	16	15.68	16.32	5	40	200	1.0	0.1	11.2	10.4	14.0
TKBZX84B18	2Y6	18	17.64	18.36	5	45	225	1.0	0.1	12.6	12.4	16.0
TKBZX84B20	2Y7	20	19.60	20.40	5	55	225	1.0	0.1	14.0	14.4	18.0
TKBZX84B22	2Y8	22	21.56	22.44	5	55	250	1.0	0.1	15.4	16.4	20.0
TKBZX84B24	2Y9	24	23.52	24.48	5	70	250	1.0	0.1	16.8	18.4	22.0
TKBZX84B27	2Y10	27	26.46	27.54	2	80	300	0.5	0.1	18.9	21.4	25.3
TKBZX84B30	2Y11	30	29.40	30.60	2	80	300	0.5	0.1	21.0	24.4	29.4
TKBZX84B33	2Y12	33	32.34	33.66	2	80	325	0.5	0.1	23.1	27.4	33.4
TKBZX84B36	2Y13	36	35.28	36.72	2	90	350	0.5	0.1	25.2	30.4	37.4
TKBZX84B39	2Y14	39	38.22	39.78	2	130	350	0.5	0.1	27.3	33.4	41.2

**Notes:**

1. Valid provided that device terminals are kept at ambient temperature.
2. Tested with pulses, period=5ms,pulse width =300μs.
3. f=1kHz.

### Typical Characteristics

Notes: Our company currently provide 5.1 V - 20 V products only

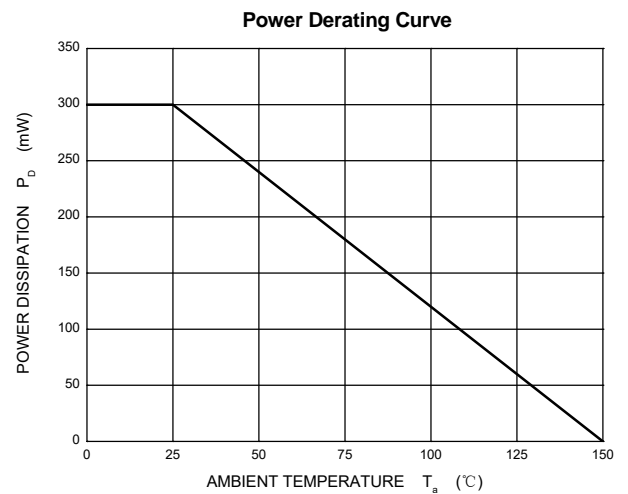
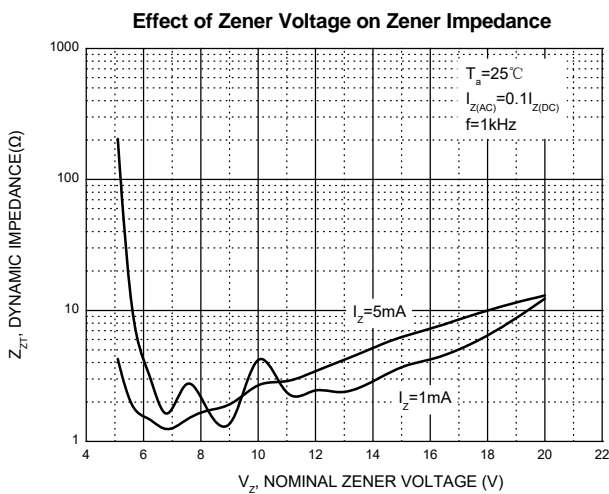
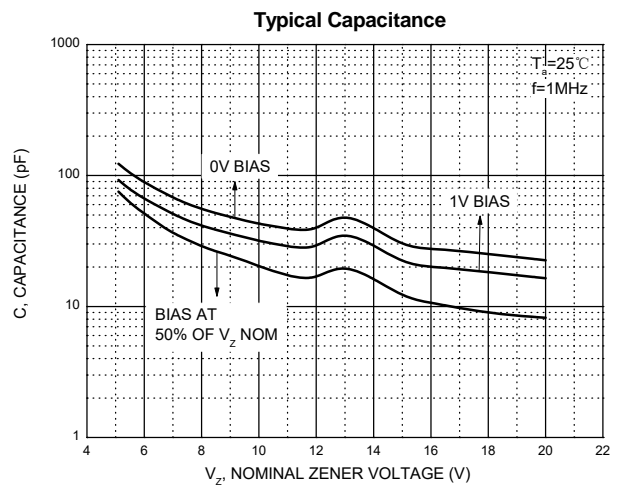
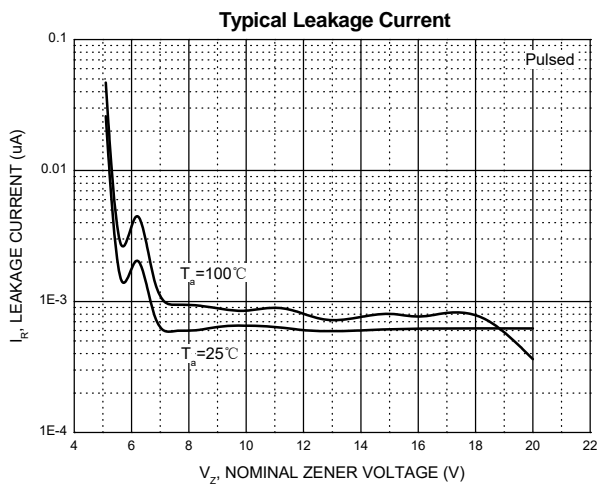
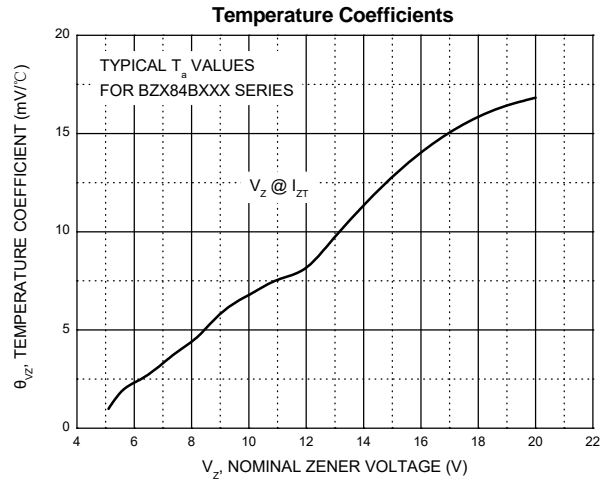
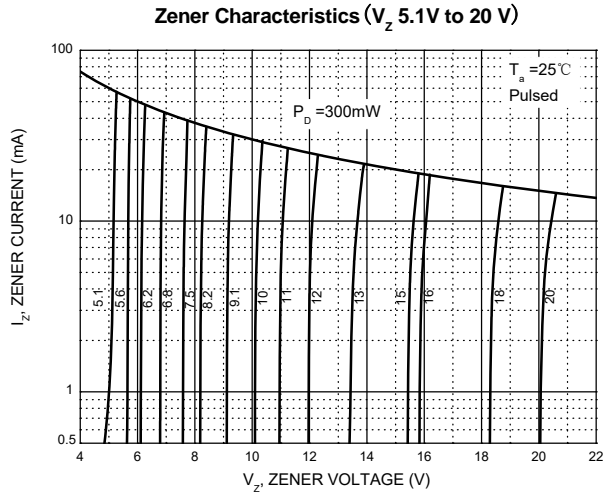

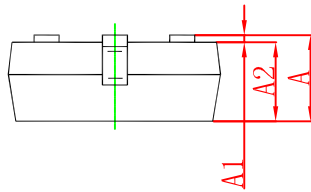
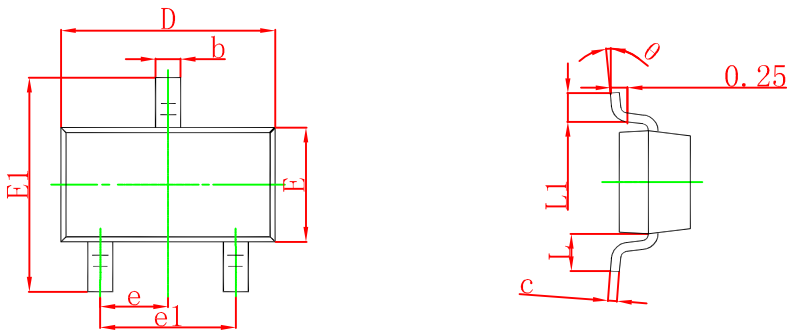

Symbol	Dimensions In Millimeters		Dimensions In Inches	
	Min	Max	Min	Max
A	0.900	1.150	0.035	0.045
A1	0.000	0.100	0.000	0.004
A2	0.900	1.050	0.035	0.041
b	0.300	0.500	0.012	0.020
c	0.080	0.150	0.003	0.006
D	2.800	3.000	0.110	0.118
E	1.200	1.400	0.047	0.055
E1	2.250	2.550	0.089	0.100
e	0.950 TYP		0.037 TYP	
e1	1.800	2.000	0.071	0.079
L	0.550 REF		0.022 REF	
L1	0.300	0.500	0.012	0.020
θ	0°	8°	0°	8°

### SOT-23 Suggested Pad Layout

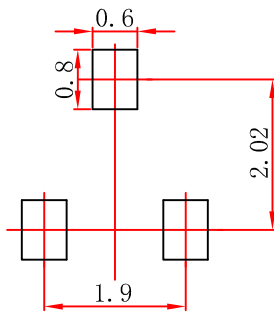

- Note:
1. Controlling dimension: in millimeters.
  2. General tolerance:  $\pm 0.05$  mm.
  3. The pad layout is for reference purposes only.